



SECTION 3
COMMERCIAL DOORS,
PARTITIONS & PATCH FITTINGS



Wholesale Price List OCT 2023

www.opushardware.com

SECTION 3 | COMMERCIAL DOORS, PARTITIONS & PATCH FITTINGS

Product	Page
Door Springs & Closers	3 - 4
Patch Fittings	3 - 11
Patch Components	6 & 10
Indicator Locks for Swing Doors	12
Lever Locks or Latchsets	13
Vienna Hydraulic Door Hinges	15
Door Rails and Components	16 - 17
Pulls & Door Handles	See Catalogue Section 5 (Handles & Pulls)
Sliding Doors & Roller Systems	See Catalogue Section 4 (Sliding Door Systems)
Glazing Channel & End Caps	18 - 20
Fin Brackets	21
Door Seals	22 - 23
Packers & Setting Block	24
Patch Fitting Application Guide	25

Product availability

 Popular Item (Usually readily available, ex stock)	 Slower Mover/ Lead Time applies (Check stock status)	 Limited Stocks Available
--	--	---

*Please note, availability chart is only an indication of stock expectation and is not guaranteed.
(Unforeseen/unusual demand or popularity can affect stock levels)

MORITZ SELF-CLOSING PATCH

PRODUCT	DESCRIPTION
---------	-------------



Moritz EN3/EN5 Hydraulic Self-Closing Patch

Bottom mounted to timber, steel or concrete. Suits 10–15mm toughened safety glass.

Includes base pivot plate



(Standard) EN3 - Residential and commercial internal use only. Applicable for single or double doors with a width of 750mm to 1000mm and weight up to 100kg each.

(Heavy Duty) EN5 - Residential and commercial internal & external use. Applicable for single or double doors with a width of 1000mm (Max External) to 1250mm (Max Internal) and weight up to 100kg each.

Used in conjunction with a standard top patch fitting and floor stop.

Multiple adjustments and settings for closing and breaking speed.

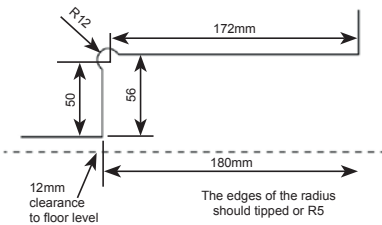
5 year Warranty

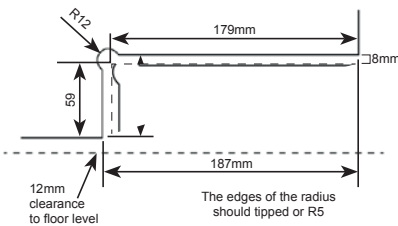
PRODUCT	TYPE	FINISH	CODE	PRICE
 <div style="display: flex; align-items: center;">  </div> <p>EN3 STANDARD</p>	HOLD OPEN	PSS	EPCHOPS	●
		SSS	EPCHOSS	●
		Black	EPCHOBK	●
	NON HOLD OPEN	PSS	EPCNHOPS	●
		SSS	EPCNHOSS	●
		Black	EPCNHOBK	●
 <div style="display: flex; align-items: center;">  </div> <p>EN5 HEAVY DUTY</p>	HOLD OPEN	PSS	EPCHDHOPS	●
		SSS	EPCHDHOSS	●
		Black	EPCHDHOBK	●
	NON HOLD OPEN	PSS	EPCHDNHOPS	●
		SSS	EPCHDNHOSS	●
		Black	EPCHDNHOBK	●

Max. opening angle 150°

Hold open at 90°

Non-hold open, by request

Two speed adjustment:

Closing speed (150° down to 10°)

Breaking speed (10° down to 0°)

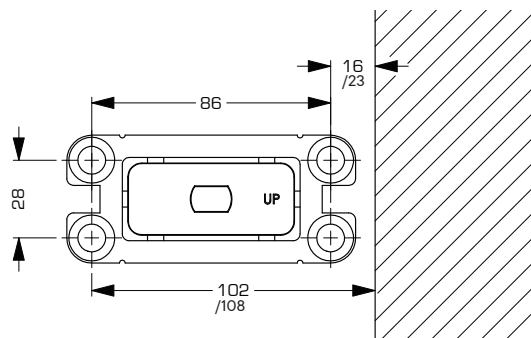
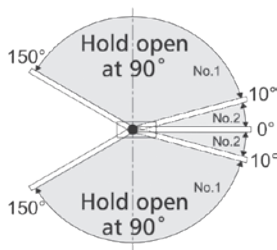

Base plate hole locations

FLOOR/OVERHEAD DOOR SPRINGS

PRODUCT	DESCRIPTION
---------	-------------



EFS840/MFX840/BTS84 Standard Floor Spring

Double action floorspring with Stainless steel (cover plate)
Maximum door weight 100kg, with widths up to 1100mm on standard spring and 800mm on weak spring.

2 speed hydraulic control; closing adjustment 130°-15°, latching adjustment 15°-0°

Spindle heights from STD to 50mm extension (5mm increments). Use with frameless patch fittings and rails.

Warranty 5years or 500,000 cycles

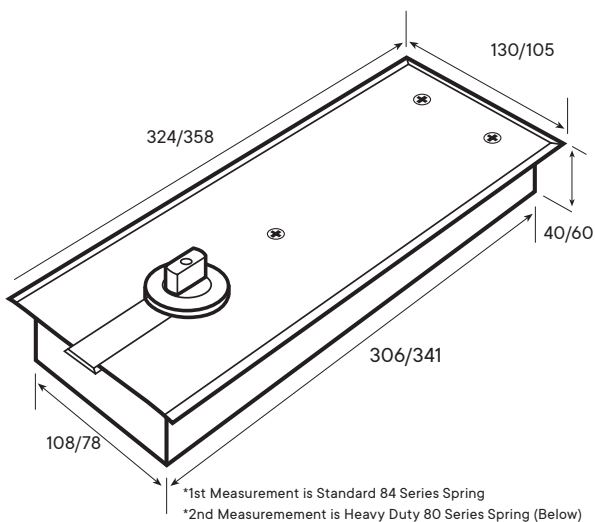

STRENGTH	TYPE	CODE	PRICE
15NM Weak	Non Hold Open	EFS840NHOW	●
	Hold Open	EFS840HOW	●
25NM Standard	Non Hold Open	EFS840NHO	●
	Hold Open	EFS840HO	●

PRODUCT	DESCRIPTION
---------	-------------



BTS80 Heavy Duty Floor Spring

Double action floorspring with Stainless steel (cover plate). Maximum door weight 300kg, with widths up to 1400mm. Selective multi-point hold open adjustable between approximately 75° and 175°. Mechanical backcheck at approximately 85° and 165°. Variable closing force 53 Nm. Spindle heights from STD to 50mm extension (5mm increments). Use with frameless patch fittings and rails. Warranty 5years or 500,000 cycles

TYPE	CODE	PRICE
Non Hold Open	BTS80NHO	●
Hold Open	BTS80HO	●

PRODUCT	DESCRIPTION
---------	-------------



RTS85 Overhead Door Closer

Double action, 90°. Aluminium/wood fix
Satin Stainless coverplate

Maximum door weight 110kg, widths up to 1000mm



TYPE	CODE	PRICE
Non Hold Open	RTS85NHO	●
Hold Open	RTS85HO	●

STANDARD DOOR & PATCH FITTINGS

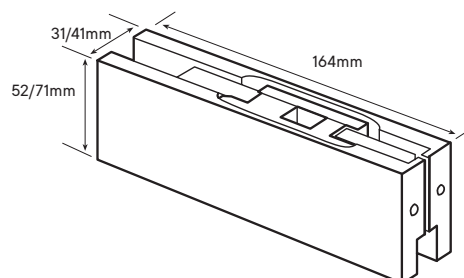
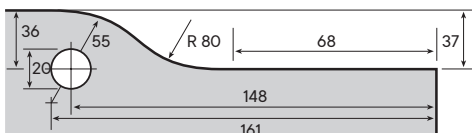
PRODUCT	DESCRIPTION	FINISH	CODE	PRICE
	HPT10/MP10 Bottom Patch Fitting Suitable for floorspring range and HPT26 free swing pivot Suits 10mm or 12mm glass. Adjustable pivot insert, Factory set at 55mm.	Polished Stainless	HPT10-PS	●
		Satin Stainless	HPT10-SS	●
		Black	HPT10-BK	●
	HPT20/MP20 Top Patch Fitting Suitable for HPT24, HPT25, HPT34, HPT40 and HPT41 pivots Suits 10mm or 12mm glass. Adjustable pivot insert, Factory set at 55mm.	Polished Stainless	HPT20-PS	●
		Satin Stainless	HPT20-SS	●
		Black	HPT20-BK	●
	HPT22/MP22 Top Patch Fitting Suitable for RTS85 overhead closer. Suits 10mm or 12mm glass. Adjustable pivot insert, Factory set at 55mm. Reversible to 65mm	Polished Stainless	HPT22-PS	●
		Satin Stainless	HPT22-SS	●
		Black	HPT22-BK	●
	HPT100/XL10 Bottom Heavy Duty Patch Suitable for floorspring range and HPT26 free swing pivot Suits 15mm to 19mm glass. Adjustable pivot insert.	Polished Stainless	HPT100-PS	●
		Satin Stainless	HPT100-SS	●
		Black	HPT100-BK	●
	HPT200/XL20 Top Heavy Duty Patch Suitable for HPT24, HPT25 and HPT400 pivots. Suits 15mm to 19mm glass. Adjustable pivot insert.	Polished Stainless	HPT200-PS	●
		Satin Stainless	HPT200-SS	●
		Black	HPT200-BK	●



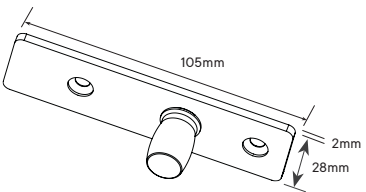
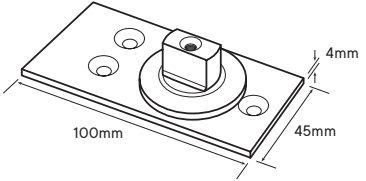
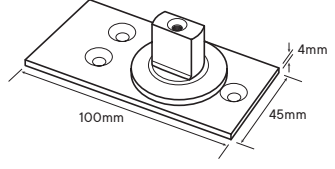
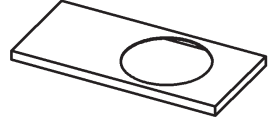
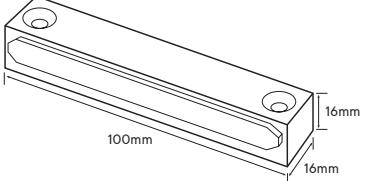

DOOR & PATCH FITTINGS

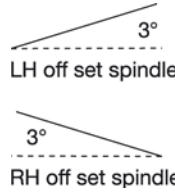
PRODUCT	DESCRIPTION	FINISH/TYPE	CODE	PRICE
	HPT24 Plate mounted pin. Suitable for use with HPT20/HPT200 patch and RL2 and RL4 top rails	Polished Stainless	HPT24-PS	●
		Satin Stainless	HPT24-SS	●
		Black	HPT24-BK	●
	HPT25 8mm metric thread, Plated Steel 44mm diameter face washer Suitable for use with HPT20 patch and RL2 and RL4 top rails	Polished Stainless	HPT25-PS	●
		Satin Stainless	HPT25-SS	●
		Black	HPT25-PBK	●
	HPT26 Free swing floor pivot Suitable for use with HPT10 and RL1 and RL3 bottom rails	Satin Stainless	HPT26-SS	●
	HPT26 EXT5 Floor pivot bearings Free swing floor pivot. Suitable for use with HPT10 and RL1 and RL3 bottom rails, extended spindle	Satin Stainless	HPT26EXT5-SS	●
	HPT26CP Cover Plate	Satin Stainless	HPT26CP-SS	●
		Polished Stainless	HPT26CP-PS	●
	HPT28 Head Stop Rubber infill stop. Available for single or double door installations. Specify HPT28S for single door	Satin Stainless	HPT28-SS	●
		Polished Stainless	HPT28-PS	●
	HPT28D Head Stop Rubber infill stop. Available for single or double door installations. Specify HPT28D for double door	Satin Stainless	HPT28D-SS	●
		Polished Stainless	HPT28D-PS	●
	Floor Spring Spindles Suits floor springs, * Please specify if you require Offset 3 degrees for single action LH or RH	Standard (30mm)	300544	●
		5mm	300545	●
		10mm	300538	●
		15mm	300539	●
		20mm	300540	●
		25mm	300541	●
		40mm	300542	●
50mm	300543	●		

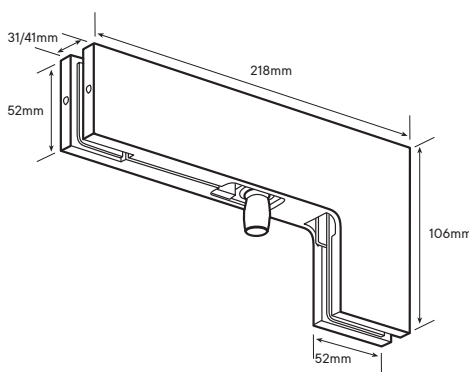
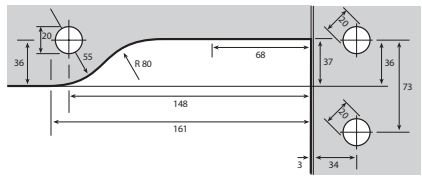

DOOR & PATCH FITTINGS

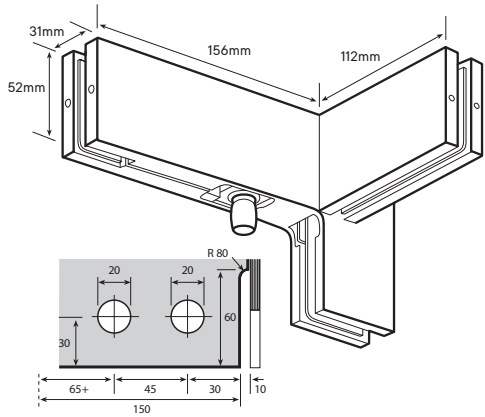
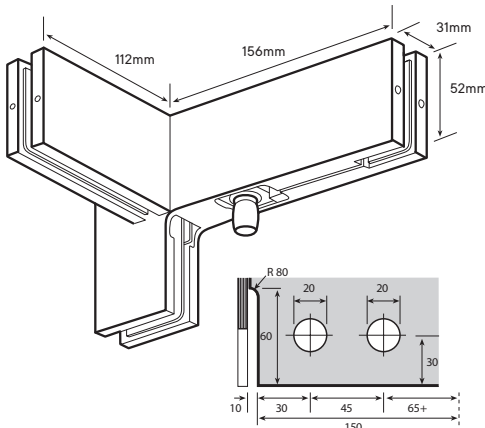
PRODUCT	DESCRIPTION	FINISH	CODE	PRICE
	<p>HPT40/MP40 Over to Side Panel Pivot Patch</p> <p>Fixing with pivot pin. Adjustable pivot insert. Suitable for use with HPT20/200 & with 10,12mm & 15,19mm glass. Pivot pin can be removed and replaced with a stop for single action door when this patch is used for an over to side panel.</p>	Polished Stainless	HPT40-PS	●
		Satin Stainless	HPT40-SS	●
		Black	HPT40-BK	●
 	<p>HEAVY DUTY XL</p> <p>Satin Stainless</p>		HPT400-SS	●
	<p>HPT41/MP41 LH Over to Side Panel Pivot Patch including Fin</p> <p>Patch for over to side panel with fin at 90°. Suitable for use with HPT20 & with 10-12mm glass. Adjustable pivot insert.</p>	Polished Stainless	HPT41L-PS	●
		Satin Stainless	HPT41L-SS	●
		Black	HPT41L-BK	●
	<p>HPT41/MP41 RH Over to Side Panel Pivot Patch including Fin</p> <p>Patch for over to side panel with fin at 90°. Suitable for use with HPT20 & with 10-12mm glass. Adjustable pivot insert.</p>	Polished Stainless	HPT41R-PS	●
		Satin Stainless	HPT41R-SS	●
		Black	HPT41R-BK	●

DOOR & PATCH FITTINGS

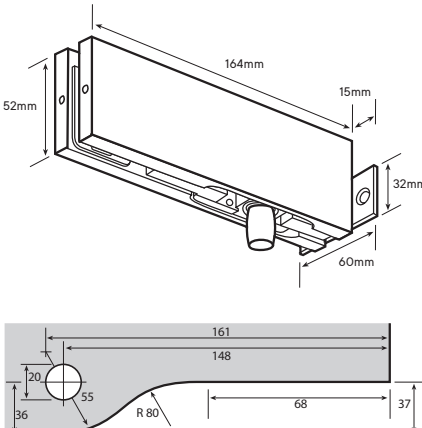
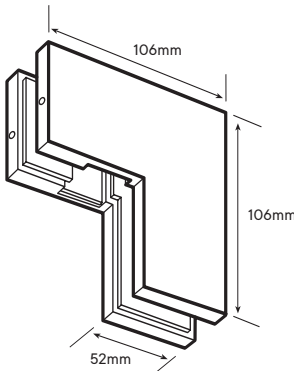
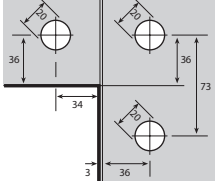
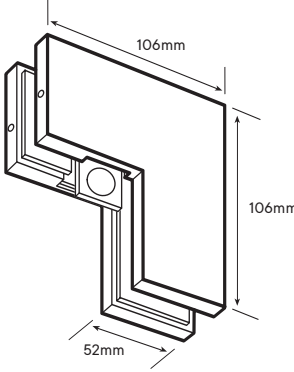
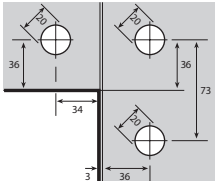
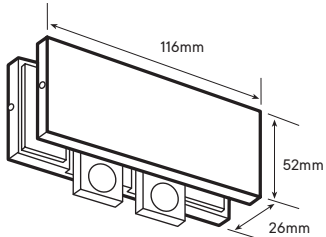
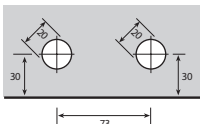
PRODUCT	DESCRIPTION	FINISH	CODE	PRICE
	HPT30/34 Overpanel Pivot Patch Fixing overpanel to wall fitted with pivot pin. use with HPT20. Suits 10–12mm glass. Adjustable pivot insert. Factory set at 55mm. HPT30 (Patch only) HPT34 (Includes Backplate)	Satin Stainless	HPT30-SS	●
		Polished Stainless	HPT30-PS	●
		Black	HPT30-BK	●
		Satin Stainless	HPT34-SS	●
		Polished Stainless	HPT34-PS	●
		Black	HPT34-BK	●
	HPT60 Overpanel to Side Panel Patch Fitting Suits 10mm & 12mm glass	Polished Stainless	HPT60-PS	●
		Satin Stainless	HPT60-SS	●
	HPT61 Overpanel to Side Panel Patch Fitting Suits 10mm & 12mm glass Includes removable single action door stop	Polished Stainless	HPT61-PS	●
		Satin Stainless	HPT61-SS	●
	HPT70 Overpanel Patch incorporating Stops for Single Action Double Doors Stops removable and reversible Suits 10mm & 12mm glass	Polished Stainless	HPT70-PS	●
		Satin Stainless	HPT70-SS	●

PATCH LOCKS

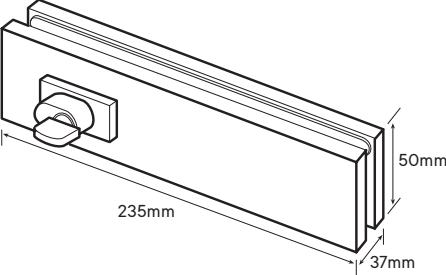
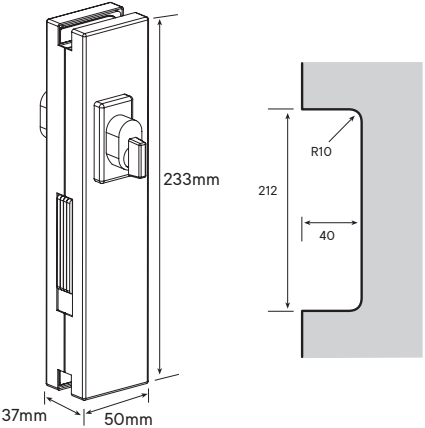
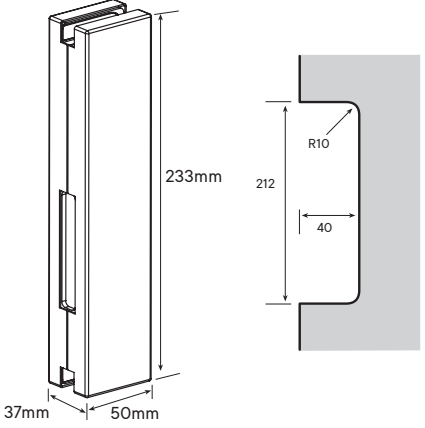
PRODUCT	DESCRIPTION	FINISH	CODE	PRICE
	<p>PL590 Bottom or Top Patch Lock</p> <p>Complete with lock and cylinders</p> <p>Specify cylinder combination e.g. Double cylinder, Cylinder/Turn, Single cylinder & Single turn</p> <p>Use with keeper LK590/GK590</p> <p>Suits 10–12mm glass</p>	Polished Satin	PL590-PA	●
		Satin Stainless	PL590-SS	●
		Black	PL590-BK	●
	<p>CPL590 Centre Patch Lock</p> <p>Complete with lock and cylinders</p> <p>Specify cylinder combination e.g. Double cylinder, Cylinder/Turn, Single cylinder & Single turn</p> <p>Use with keepers CPK590 and LK590</p> <p>Suits 10–12mm glass</p>	Polished Satin	CPL590-PA	●
		Satin Stainless	CPL590-SS	●
		Black	CPL590-BK	●
	<p>CPK590 Centre Patch Keeper</p> <p>Use with CPL590</p> <p>Suits 10–12mm glass</p>	Polished Satin	CPK590-PA	●
		Satin Stainless	CPK590-SS	●
		Black	CPK590-BK	●

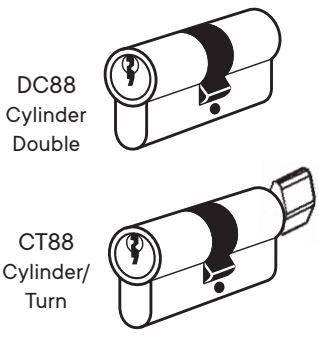
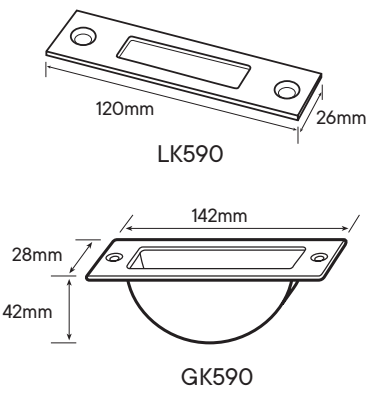
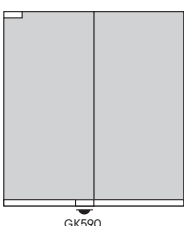
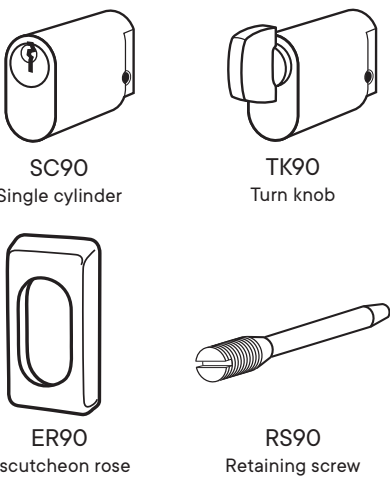
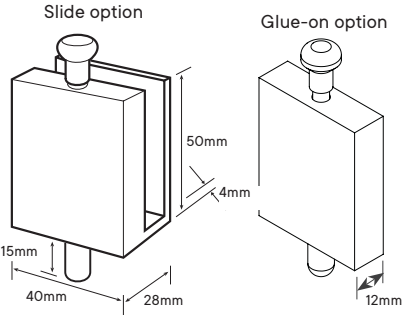

PATCH LOCKS

PRODUCT	DESCRIPTION	FINISH	CODE	PRICE
 <p>DC88 Cylinder Double</p> <p>CT88 Cylinder/ Turn</p>	<p>DC88/CT88 Eurostyle Cylinders</p> <p>Used with EL10</p>	Chrome Plate	DC88-CP	●
		Satin Chrome	DC88-SC	●
		Chrome Plate	CT88-CP	●
		Satin Chrome	CT88-SC	●
 <p>LK590</p> <p>GK590</p>	<p>LK590/GK590 Lockwood 590 Groundkeeper</p> <p>LK590 - Used with PL590 and CPL590 locks & rails</p> <p>GK590 - Used with rail locks & PL590</p> 	Stainless Steel	LK590	●
		Satin Silver Anodised	GK590	●
 <p>SC90 Single cylinder</p> <p>TK90 Turn knob</p> <p>ER90 Escutcheon rose</p> <p>RS90 Retaining screw</p>	<p>SC90/TK90/ER90/RS90 Lockwood accessories 590 patch locks</p> <p>Used with rail locks</p>	Satin Silver Anodised	SC90	●
			TK90	●
			ER90	●
			RS90	●
 <p>Slide option</p> <p>Glue-on option</p>	<p>374 Straddle Fix Bolt Lock</p> <p>Suitable for 10mm or 12mm thick glass. No cut out of glass panel required. Silicon fixing. SSS Finish</p> <p>Tubular groundkeeper included</p> <p>Slide and glue-on options</p>	Slide Option	374SA	●
		Glue On	374GSA	●

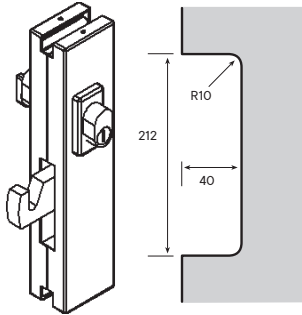
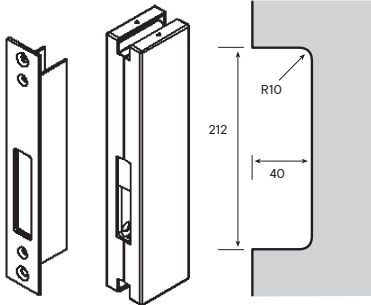
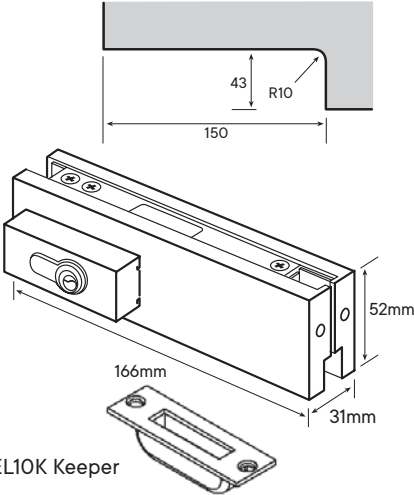
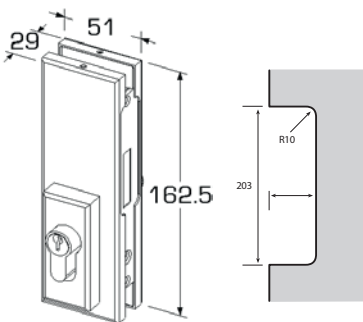
PATCH LOCKS





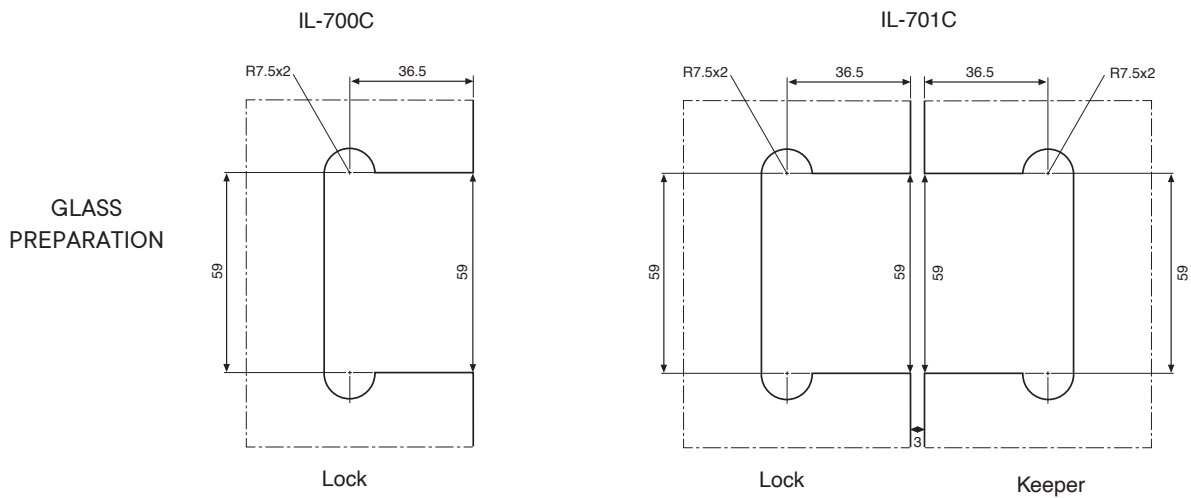

PRODUCT	DESCRIPTION	FINISH	CODE	PRICE
	<p>CPL590P Parrot Beak Patch</p> <p>For sliding doors</p> <p>Complete with lock and cylinders</p> <p>Specify cylinder combination e.g. Double cylinder, Cylinder/Turn, Single cylinder & Single turn</p> <p>Use with keeper CPK590P</p> <p>Suits 10mm & 12mm glass</p>	Polished Satin	CPL59P-PS	●
		Satin Stainless	CPL59P-SS	●
 <p>WK590P</p>	<p>CPK590P Parrot Beak Keeper</p> <p>For sliding doors</p> <p>Use with CPL590P</p> <p>Suits 10mm & 12mm glass</p>	Polished Satin	CPK590P-PS	●
		Satin Stainless	CPK590P-SS	●
 <p>EL10K Keeper</p>	<p>EL10PL Top/Bottom Patch Lock</p> <p>Vertical bolt projection 20mm</p> <p>Eurotype cylinders</p> <p>Specify cylinder combination e.g. double cylinder, cylinder/turn, single cylinder & single turn</p> <p>Suits 10mm or 12mm glass</p>	Polished Satin	EL10PL-PS	●
		Satin Stainless	EL10PL-SS	●
	<p>EL10CPL Centre Patch Lock</p> <p>Vertical bolt projection 20mm</p> <p>Eurotype cylinders</p> <p>Specify cylinder combination e.g. double cylinder, cylinder/turn, single cylinder & single turn.</p> <p>Suits 10mm or 12mm glass</p> <p>Striker box is available (code EL10CPK)</p>	Polished Satin	EL10CPL-PS	●
		Satin Stainless	EL10CPL-SS	●

INDICATOR LOCKS FOR SWING DOORS

PRODUCT	DESCRIPTION	FINISH	CODE	PRICE
	Indicator Lock Door to Wall (Glass Cut Out Required)	Polished Chrome	IL700C	●
	For Toilet and Bathroom Doors. To suit 8mm and 10mm glass.	Satin Chrome	IL700C	●
	Indicator Lock Door to Sidepanel (Glass Cut Outs Required)	Polished Chrome	IL701C	●
	For Toilet and Bathroom Doors. To suit 8mm and 10mm glass.	Satin Chrome	IL701C	●
	Indicator Lock Door to Wall (No Glass Cut Out Required)	Polished Chrome	IL600C	●
	For Toilet and Bathroom Doors. To suit 8mm and 10mm glass.	Satin Chrome	IL600C	●
	Indicator Lock Door to Sidepanel (No Glass Cut Outs Required)	Polished Chrome	IL601C	●
	For Toilet and Bathroom Doors. To suit 8mm and 10mm glass.	Satin Chrome	IL601C	●



LEVER LOCKS AND LATCH SETS

PRODUCT	DESCRIPTION	FINISH	CODE	PRICE
	Lever Lockset with Cylinder Locking to timber or aluminium jamb	Polished Stainless	LLJ-01-PS	●
	Specify 10mm or 12mm glass thickness	Satin Stainless	LLJ-01-SS	●
	Lever Lockset Locking to glass sidelight	Polished Stainless	LLG-02-PS	●
	Specify 10mm or 12mm glass thickness	Satin Stainless	LLG-02-SS	●
	Lever Latchset Latching to timber or aluminium jamb	Polished Stainless	LLJ-03-PS	●
	Specify 10mm or 12mm glass thickness	Satin Stainless	LLJ-03-SS	●
	Lever Latchset Latching to glass sidelight	Polished Stainless	LLG-04-PS	●
	Specify 10mm or 12mm glass thickness	Satin Stainless	LLG-04-SS	●
	Strike Box For Glass Sidelight	Polished Stainless	LSG-08-PS	●
	Specify 10mm or 12mm glass thickness	Satin Stainless	LSG-08-SS	●
	Strike Plate For Aluminium or Timber Jamb	Polished Stainless	LSJ-09-PS	●
	Specify 10mm or 12mm glass thickness	Satin Stainless	LSJ-09-SS	●

GLASS PREPARATION

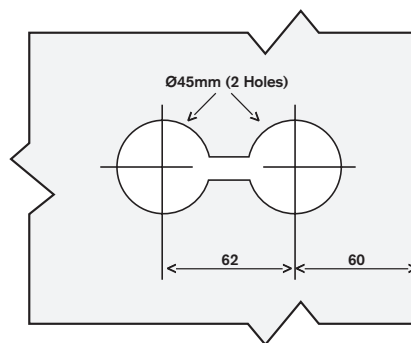



VIENNA HYDRAULIC HINGES

PRODUCT	DESCRIPTION	TYPE	FINISH	CODE	PRICE
	<p>EH4 VIENNA Hydraulic Hinge Glass to Wall</p> <p>Hinge opening angle 100°. Self-closing from any angle. Available in non-hold open and hold open options. Centre T Style backplate.</p> <p>Max recommended glass weight: 70kg Max recommended door span: 900mm Standard for 12mm glass, can be supplied for 10–15mm on request.</p> <p>*SOLD AS A PAIR (2x Hinges)</p>	NON-HOLD OPEN	Satin Stainless	EH4NHOSS	●
			Polished Stainless	EH4NHOPS	●
		HOLD OPEN	Satin Stainless	EH4HOSS	●
			Polished Stainless	EH4HOPS	●
	<p>EH4L VIENNA Hydraulic Hinge Glass to Wall, Offset</p> <p>Hinge opening angle 100°. Self-closing from any angle. Available in non-hold open and hold open options. Offset L Style backplate.</p> <p>Max recommended glass weight: 70kg Max recommended door span: 900mm Standard for 12mm glass, can be supplied for 10–15mm on request.</p> <p>*SOLD AS A PAIR (2x Hinges)</p>	NON-HOLD OPEN	Satin Stainless	EH4NHOLSS	●
			Polished Stainless	EH4NHOLPS	●
		HOLD OPEN	Satin Stainless	EH4HOLSS	●
			Polished Stainless	EH4HOLPS	●
	<p>EH3 VIENNA Hydraulic Hinge Glass to Glass</p> <p>Hinge opening angle 100°. Self-closing from any angle. Available in non-hold open and hold open options. Glass to Glass Style.</p> <p>Max recommended glass weight: 70kg Max recommended door span: 900mm Standard for 12mm glass, can be supplied for 10–15mm on request.</p> <p>*SOLD AS A PAIR (2x Hinges)</p>	NON-HOLD OPEN	Satin Stainless	EH3NHOSS	●
			Polished Stainless	EH3NHOPS	●
		HOLD OPEN	Satin Stainless	EH3HOSS	●
			Polished Stainless	EH3HOPS	●

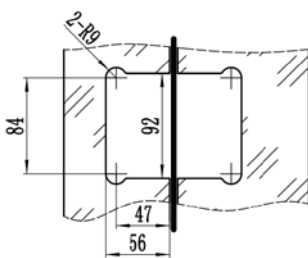

Glass-Glass

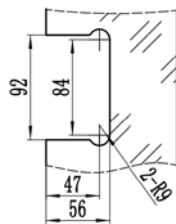

Glass-Wall

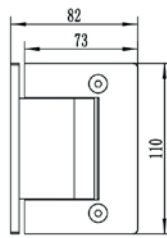



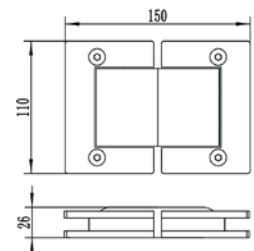
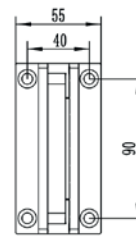

90° Glass-Wall



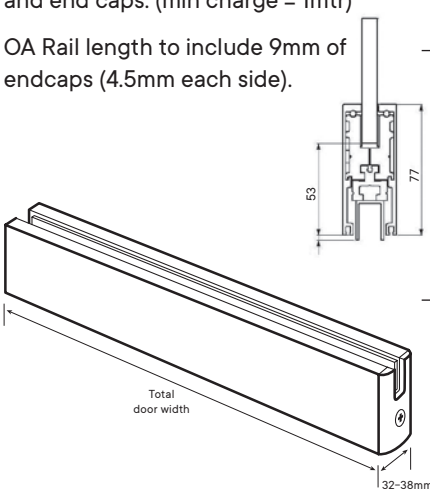

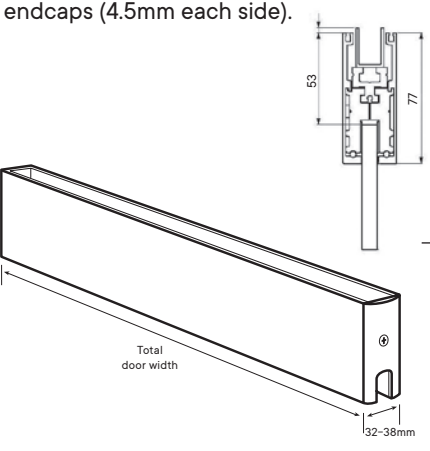

180° Glass-Glass

DOOR RAILS

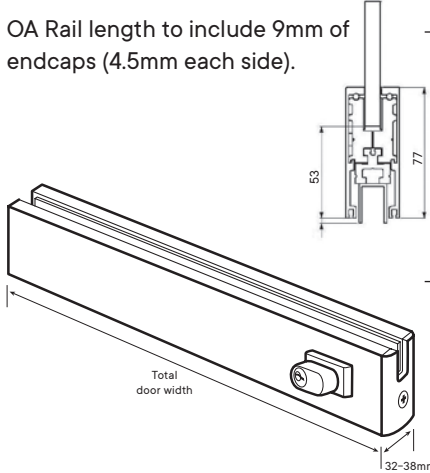
DESCRIPTION	INSERT TYPE	GLASS SIZE	FINISH	CODE	PRICE
<p>DR10 Bottom Door Rail (Non Locking)</p> <p>Sold by the meter with cover plates and end caps. (min charge = 1mtr)</p> <p>OA Rail length to include 9mm of endcaps (4.5mm each side).</p> 	<p>Pivoting (to suit) Floor Spring</p> <p><i>(Max Floor Spring Capacity 1400mm wide or 300kgs)</i></p>	10-12mm	ANO	DR10-F12-ANO	●
			Powder Coated	DR10-F12-PC	●
		15mm	ANO	DR10-F15-ANO	●
			Powder Coated	DR10-F15-PC	●
		19mm	ANO	DR10-F19-ANO	●
			Powder Coated	DR10-F19-PC	●
	<p>Pivoting (to suit) Floor Pivot</p>	10-12mm	ANO	DR10-P12-ANO	●
			Powder Coated	DR10-P12-PC	●
		15mm	ANO	DR10-P15-ANO	●
			Powder Coated	DR10-P15-PC	●
		19mm	ANO	DR10-P19-ANO	●
			Powder Coated	DR10-P19-PC	●
<p>N/A Blank (Sliding/Sidlight)</p> <p><i>(NOTE: additional floor guides & roller attachments available, not included.)</i></p>	10-12mm	ANO	DR10-12-ANO	●	
		Powder Coated	DR10-12-PC	●	
	15mm	ANO	DR10-15-ANO	●	
		Powder Coated	DR10-15-PC	●	
	19mm	ANO	DR10-19-ANO	●	
		Powder Coated	DR10-19-PC	●	
	<p>Rail Guide</p> <p>FGR guide for sliding rail</p>		Black Nylon	FGR	●
<p>DR20 Top Door Rail (Non Locking)</p> <p>Sold by the meter with cover plates and end caps. (min charge = 1mtr)</p> <p>OA Rail length to include 9mm of endcaps (4.5mm each side).</p> 	<p>Pivoting (to suit) RTS85 Closer</p> <p><i>(RTS85 Capacity 1000mm wide Max or 110kgs)</i></p>	10-12mm	ANO	DR20-R12-ANO	●
			Powder Coated	DR20-R12-PC	●
		15mm	ANO	DR20-R15-ANO	●
			Powder Coated	DR20-R15-PC	●
		19mm	ANO	DR20-R19-ANO	●
			Powder Coated	DR20-R19-PC	●
	<p>Pivoting (to suit) Top Pivot Pin</p>	10-12mm	ANO	DR20-P12-ANO	●
			Powder Coated	DR20-P12-PC	●
		15mm	ANO	DR20-P15-ANO	●
			Powder Coated	DR20-P15-PC	●
		19mm	ANO	DR20-P19-ANO	●
			Powder Coated	DR20-P19-PC	●
<p>N/A Blank (Sliding/Sidlight)</p> <p><i>(NOTE: additional floor guides & roller attachments available, not included.)</i></p>	10-12mm	ANO	DR20-12-ANO	●	
		Powder Coated	DR20-12-PC	●	
	15mm	ANO	DR20-15-ANO	●	
		Powder Coated	DR20-15-PC	●	
	19mm	ANO	DR20-19-ANO	●	
		Powder Coated	DR20-19-PC	●	
	<p>Glass Guide</p> <p>Sliding Door guide for frameless glass bottom.</p>		ANO	300967	●

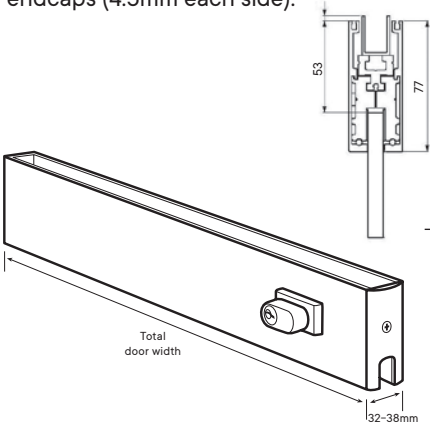
DOOR RAILS

DESCRIPTION	INSERT TYPE	GLASS SIZE	FINISH	CODE	PRICE
DR30 Bottom Door Rail (Locking) Sold by the meter with cover plates and end caps. (min charge = 1mtr) OA Rail length to include 9mm of endcaps (4.5mm each side). 	Pivoting (to suit) Floor Spring <i>(Max Floor Spring Capacity 1400mm wide or 300kgs)</i>	10-12mm	ANO	DR30-F12-ANO	●
			Powder Coated	DR30-F12-PC	●
		15mm	ANO	DR30-F15-ANO	●
			Powder Coated	DR30-F15-PC	●
		19mm	ANO	DR30-F19-ANO	●
			Powder Coated	DR30-F19-PC	●
	Pivoting (to suit) Floor Pivot N/A Blank (Sliding/Sidlight) <i>(NOTE: additional floor guides & roller attachments available, not included.)</i>	10-12mm	ANO	DR30-P12-ANO	●
			Powder Coated	DR30-P12-PC	●
		15mm	ANO	DR30-P15-ANO	●
			Powder Coated	DR30-P15-PC	●
		19mm	ANO	DR30-P19-ANO	●
			Powder Coated	DR30-P19-PC	●
	Rail Guide FGR guide for sliding rail		Black Nylon	FGR	●
DR40 Top Door Rail (Locking) Sold by the meter with cover plates and end caps. (min charge = 1mtr) OA Rail length to include 9mm of endcaps (4.5mm each side). 	Pivoting (to suit) RTS85 Closer <i>(RTS85 Capacity 1000mm wide Max or 110kgs)</i>	10-12mm	ANO	DR40-R12-ANO	●
			Powder Coated	DR40-R12-PC	●
		15mm	ANO	DR40-R15-ANO	●
			Powder Coated	DR40-R15-PC	●
		19mm	ANO	DR40-R19-ANO	●
			Powder Coated	DR40-R19-PC	●
	Pivoting (to suit) Top Pivot Pin N/A Blank (Sliding/Sidlight) <i>(NOTE: additional floor guides & roller attachments available, not included.)</i>	10-12mm	ANO	DR40-P12-ANO	●
			Powder Coated	DR40-P12-PC	●
		15mm	ANO	DR40-P15-ANO	●
			Powder Coated	DR40-P15-PC	●
		19mm	ANO	DR40-P19-ANO	●
			Powder Coated	DR40-P19-PC	●
	Glass Guide Sliding Door guide for frameless glass bottom.		ANO	300967	●

NOTE: For Locking Rails specify cylinder Type: DC - Double cylinders, SC - Single Cylinder, CT Cylinder Turn.

GLAZING CHANNEL

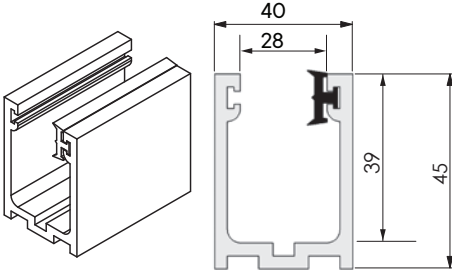
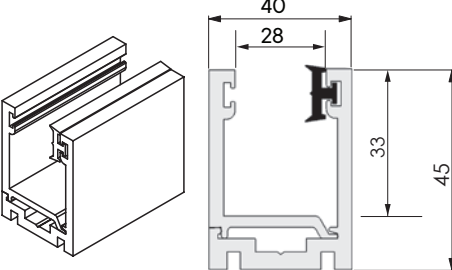
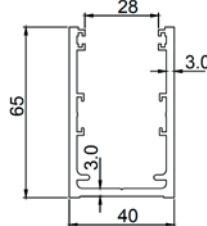
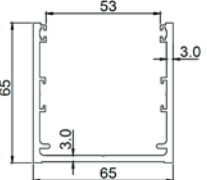
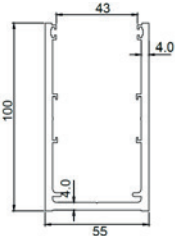
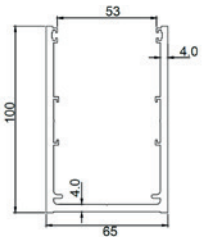

PRODUCT	DESCRIPTION	LENGTH	FINISH	CODE	PRICE
	<p>COM4/CS144 Bottom Channel 5mtr</p> <p>Heavy duty one piece architectural commercial channel section, used for interior and exterior applications.</p> <p>Suitable for 15mm to 25mm glass.</p>	5mtr	Satin Silver Anodised	COM4-SA	●
			Black	COM4-BK	●
	<p>COM5/CS244 Head/Side Channel 5mtr</p> <p>Heavy duty two-piece architectural commercial channel section, used for interior and exterior applications.</p> <p>Suitable for 15mm to 25mm glass.</p>	5mtr	Satin Silver Anodised	COM5-SA	●
			Black	COM5-BK	●
	<p>CS652 Channel</p> <p>Thickness 3mm Profile: 65x40mm</p>	5mtr	Satin Anodised	CS652-SA	●
			Black	CS652-BK	●
			MILL	CS652-MILL	●
	<p>CS654 Channel</p> <p>Thickness 3mm Profile: 65x65mm</p>	5mtr	Satin Anodised	CS654-SA	●
			Black	CS654-BK	●
			MILL	CS654-MILL	●
	<p>CS100 Shopfront Channel</p> <p>Thickness 4mm Profile: 100x55mm</p>	5mtr	Satin Anodised	CS100-SA	●
			Black	CS100-BK	●
			MILL	CS100-MILL	●
	<p>CS105 Shopfront Channel</p> <p>Thickness 4mm Profile: 100x65mm</p>	5mtr	Satin Anodised	CS105-SA	●
			Black	CS105-BK	●
			MILL	CS105-MILL	●

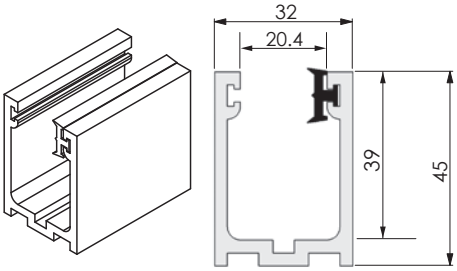
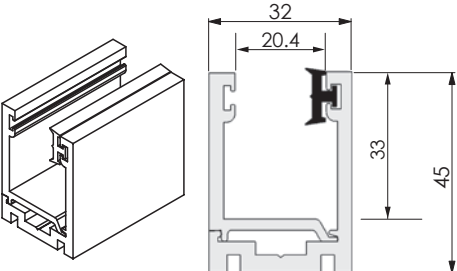
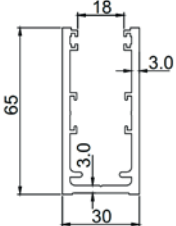
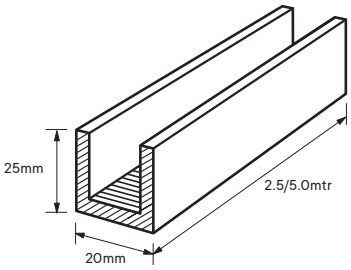
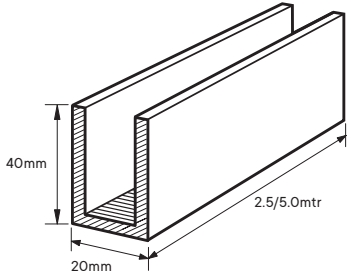
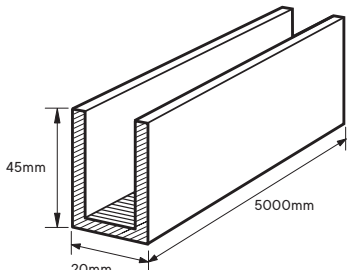
GLAZING CHANNEL

PRODUCT	DESCRIPTION	LENGTH	FINISH	CODE	PRICE
	COM1/CS134 Bottom Channel 5mtr Heavy duty one piece architectural commercial channel section, used for interior and exterior applications. Suitable for 8, 10, 12 and 15mm glass, can be used with 19mm if wet glazed	5mtr	Satin Silver Anodised	COM1-SA	●
			Black	COM1-BK	●
	COM2/CS234 Head/Side Channel 5mtr Heavy duty two-piece architectural commercial channel section, used for interior and exterior applications. Suitable for 10, 12 and 15mm glass, can be used with 19mm if wet glazed	5mtr	Satin Silver Anodised	COM2-SA	●
			Black	COM2-BK	●
	CS651 Channel Thickness 3mm Profile: 65x32mm	5mtr	Satin Anodised	CS651-SA	●
			Black	CS651-BK	●
			MILL	CS651-MILL	●
	CU25/CS25 Channel Thickness 2.5mm Profile: 25x20mm	5mtr	Satin Anodised	CU25-SA	●
			MILL	CU25-MILL	●
			Black	CU25-BK	●
			White	CU25-W	●
			2.5mtr	Bright Silver	CU25-C
	CU40/CS40 Channel Thickness 2.5mm Profile: 40x20mm	5mtr	Satin Anodised	CU40-SA	●
			MILL	CU40-MILL	●
			Black	CU40-BK	●
			White	CU40-W	●
			2.5mtr	Bright Silver	CU40-C
	CU45/CS45 Channel Thickness 2.5mm Profile: 45x20mm	5000mm	Satin Silver Anodised	CU45-SA	●

CHANNEL END CAPS & PARTS

PRODUCT	DESCRIPTION	FINISH	CODE	PRICE
	25x20mm	Satin Anodised	EC5-SA	●
		Satin Brushed	EC5-SS	●
	40x20mm	Satin Anodised	EC6-SA	●
		Satin Brushed	EC6-SS	●
	45x20mm	Satin Anodised	EC7-SA	●
		Satin Brushed	EC7-SS	●
	45x32mm	Satin Anodised	EC8-SA	●
		Satin Brushed	EC8-SS	●
	65x30mm	Satin Anodised	EC9-SA	●
		Satin Brushed	EC9-SS	●
	65x40mm	Satin Anodised	EC10-SA	●
		Satin Brushed	EC10-SS	●
	65x55mm	Satin Anodised	EC11-SA	●
		Satin Brushed	EC11-SS	●
	65x65mm	Satin Anodised	EC12-SA	●
		Satin Brushed	EC12-SS	●
	100x55mm	Satin Anodised	EC13-SA	●
		Satin Brushed	EC13-SS	●
100x65mm	Satin Anodised	EC14-SA	●	
	Satin Brushed	EC14-SS	●	

PRODUCT	DESCRIPTION	SIZE	CODE	PRICE
	Setting Block Santoprene	15mm x 17mm x 50mm	301044	●
	Pan Screws Square Drive	25mm x 10g Pan Screws Square Drive 304SS	PAN25	●
		35mm x 10g Pan Screws Square Drive 304SS	PAN55	●
		50mm x 10g Pan Screws Square Drive 304SS	PAN50	●

PRODUCT	DESCRIPTION	CODE	PRICE
	10.9 x 4.9mm - Compressed size 4mm (per metre) - Double sided for 12mm Glass with COM1 & 2	301892	●
	11.5 x 4mm - Compressed size 2.5mm (per metre) - Double sided for 15mm Glass with COM1 & 2 - Single sided for 17.5mm Glass with COM1 & 2	302022	●

NOTE: Use both wedge styles, 1 each side of COM1 & COM2 to suit 13.5mm Glass.

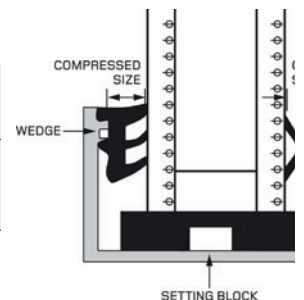

STAINLESS FIN BRACKETS

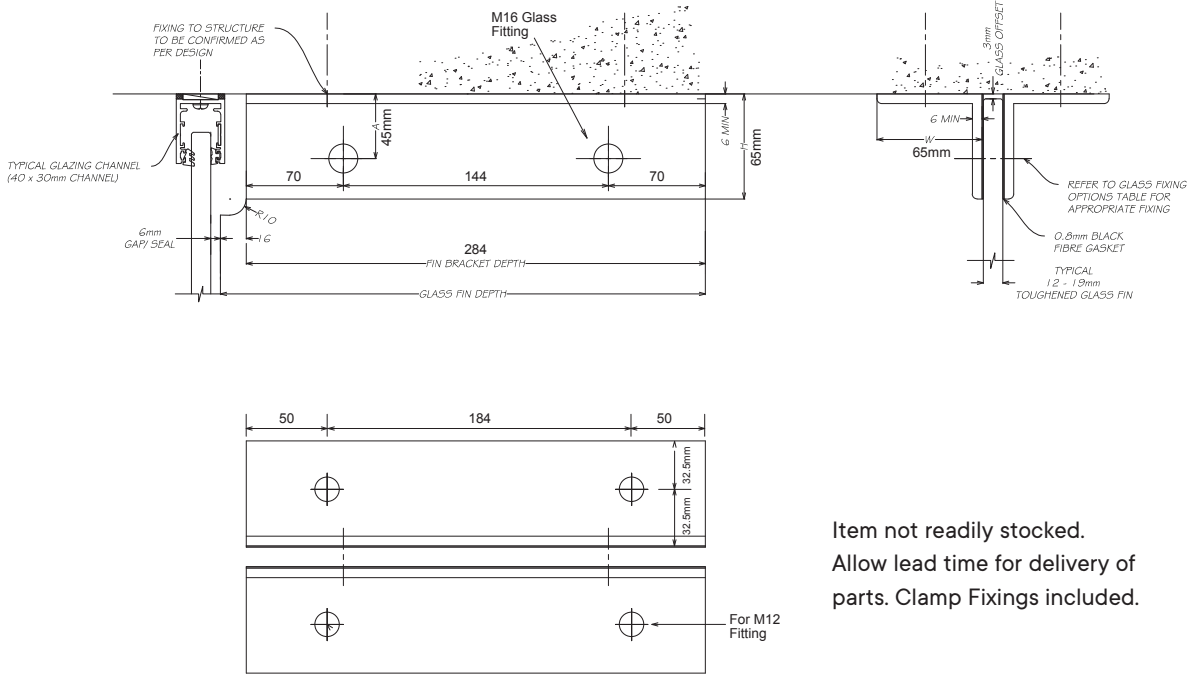

Item not readily stocked.
Allow lead time for delivery of parts. Clamp Fixings included.

PRODUCT	DESCRIPTION	FINISH	CODE	PRICE
Fin Bracket Set	To support 250mm Fin 250 x 65 x 65 x 6 Specify Glass thickness	Satin Stainless	FB-250	●
Fin Bracket Set	To support 300mm Fin 300 x 65 x 65 x 6 Specify Glass thickness	Satin Stainless	FB-300	●
Special length Fin bracket	65 x 65 x 6 Specify Glass thickness	Satin Stainless	FB-SP	●

DOOR SEALS AND COMPONENTS

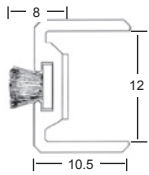
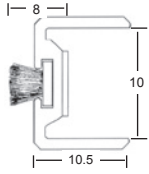
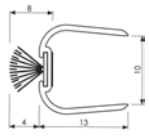
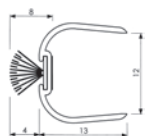
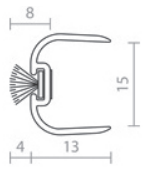
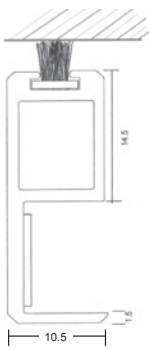
PRODUCT	DESCRIPTION	FINISH	CODE	PRICE
	<p>Anodised Aluminium Section</p> <p>With polypropylene grey pile. Includes double sided adhesive foam tape. For 12mm thick glass. Length 3000mm</p>	Silver Anodised	DS180-12	●
	<p>Anodised Aluminium Section</p> <p>With polypropylene grey pile. Includes double sided adhesive foam tape. For 10mm thick glass. Length 3000mm</p>	Silver Anodised	DS180-10	●
	<p>Clear Polycarbonate Section</p> <p>With black polypropylene pile. For 10mm thick glass. Length 3000mm</p>	Clear Poly	RP103	●
	<p>Clear Polycarbonate Section</p> <p>With polypropylene pile. For 12mm thick glass. Length 3000mm</p>	Clear Poly	RP104	●
	<p>Clear Polycarbonate Section</p> <p>With polypropylene pile. For 15mm thick glass. Length 3000mm</p>	Clear Poly	RP42	●
PRODUCT	DESCRIPTION	FINISH	CODE	PRICE
	<p>Sliding Door 90° Seal</p> <p>Anodised Aluminium Section with polypropylene grey pile. Includes double sided adhesive tape. Seal fitted to back edge of door to create seal back to side panel or wall. Profiles match DS180 seals. When ordering specify dimension 'Y'.</p>	Silver Anodised	DSS90	●
	To suit 12mm glass 3000mm length		DSS90-12-Y	●
	To suit 10mm glass 3000mm length		DSS90-10-Y	●

DOOR SEALS AND COMPONENTS

PRODUCT	DESCRIPTION
---------	-------------

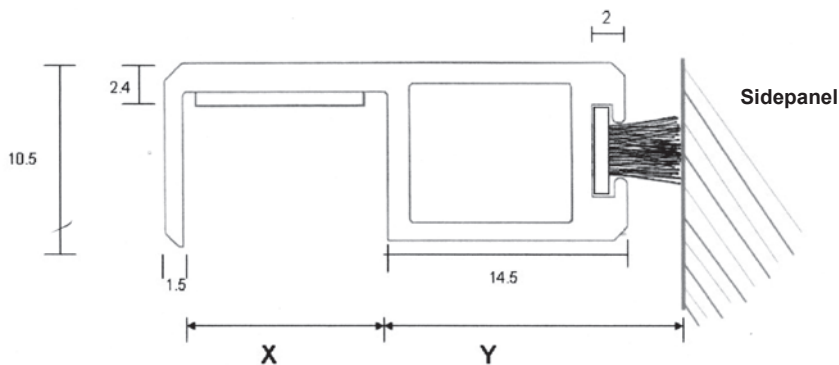

90° Door Seal













This 90° Door Seal provides a seal between Frameless Glass Sliding door panels and sidelights or walls.

Suitable for Manual or Automatic Doors. Slim profile. Will reduce draughts. Will assist with noise reduction. Available for 10mm or 12mm thick glass. Self adhesive. Profile designed to match DS180 edge seal. Available with different woolpile lengths. Supplied in 3000mm lengths.

Silver Anodised Finish with Grey woolpile

PRODUCT	DESCRIPTION	CODE	PRICE
90° Door Seal For 10mm thick glass X = 10mm	Y = 18mm Order	DSS90-10-18	●
	Y = 20mm Order	DSS90-10-20	●
	Y = 23mm Order	DSS90-10-23	●
	Y = 26mm Order	DSS90-10-26	●
	Y = 26mm Order	DSS90-10-26	●
	Y = 28mm Order	DSS90-10-28	●
	Y = 32mm Order	DSS90-10-32	●
90° Door Seal For 12mm thick glass X = 12mm	Y = 18mm Order	DSS90-12-18	●
	Y = 20mm Order	DSS90-12-20	●
	Y = 23mm Order	DSS90-12-23	●
	Y = 26mm Order	DSS90-12-26	●
	Y = 28mm Order	DSS90-12-28	●
	Y = 32mm Order	DSS90-12-32	●

PACKERS AND SETTING BLOCK

PRODUCT	DESCRIPTION	FINISH	CODE	PRICE
	Silicone Spatula		SP1	
	Plastic Packers 1.5mm	Blue	PP1.5	
	Plastic Packers 2mm	Red	PP2	
	Plastic Packers 3mm	Orange	PP3	
	Plastic Packers 4mm	Green	PP4	
	Plastic Packers 5mm	Grey	PP5	
	Plastic Packers 6mm	Black	PP6	
	Plastic Packers 10mm	Brown	PP10	
	Setting Block Santoprene 15mm x 17mm x 50mm		B12-10	

TYPICAL DOOR APPLICATION

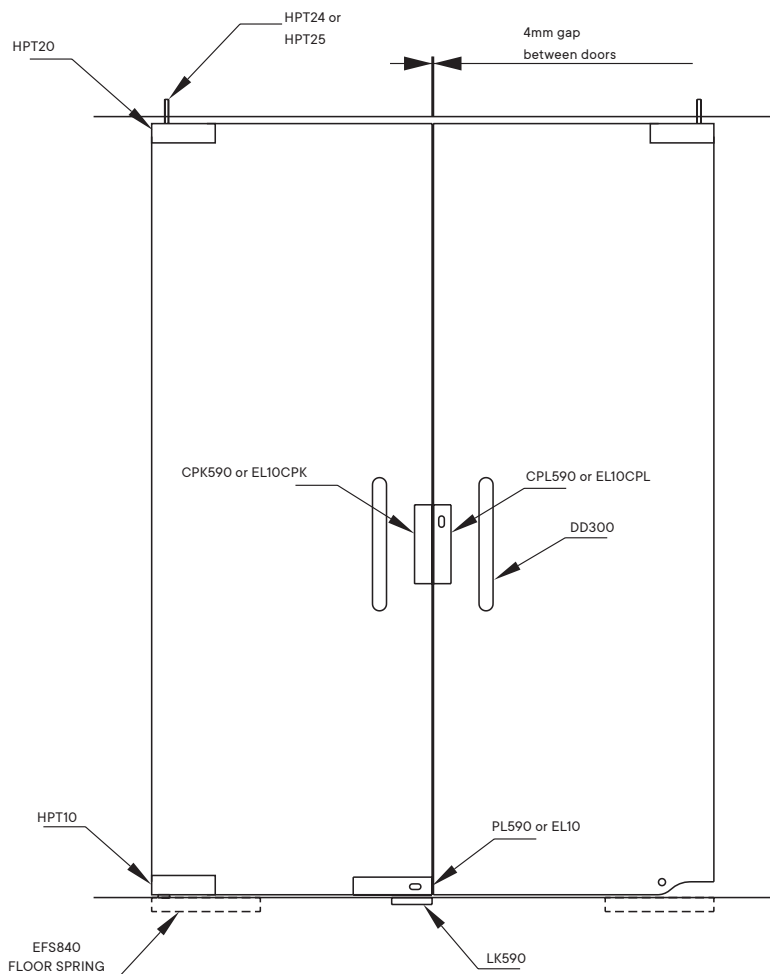

Fin Requirements

For 10mm glass

As a guide, when the height of the overpanel (A) plus the width of the side panel (B) exceeds a total of 1200mm a support fin is required. A fin is not necessary if either A or B are less than 400mm.

For 12mm glass

As a guide, when the height of the overpanel (A) plus the width of the side panel (B) exceeds a total of 1500mm a support fin is required. A fin is not necessary if either A or B are less than 500mm.

Fins are required to stiffen an assembly from the door action and windloads.

Doors

Maximum recommended sizes

For 10mm glass

Doors with patch fittings 2400h x 1000w
Doors with door rails 2500h x 1100w

For 12mm glass

Doors with patch fittings 2700h x 1100w
Doors with door rails 2700h x 1200w

Door Clearances

Recommended clearances are as detailed on drawings.

PATCH FITTING POSITIONS

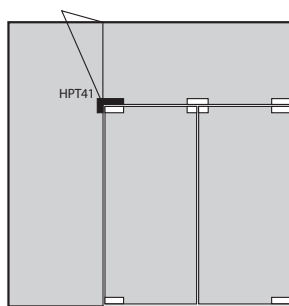
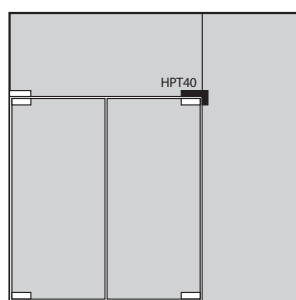

Looking at outside

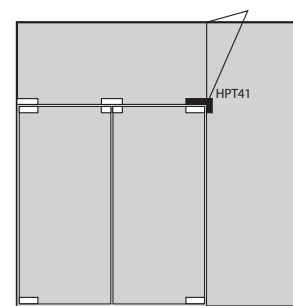

Looking at outside

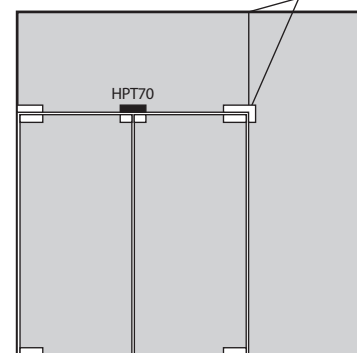
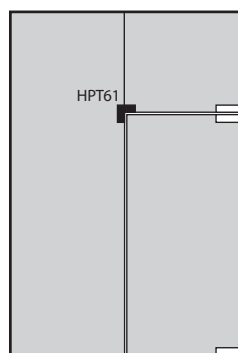
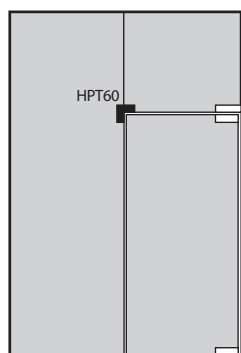



0800 404 043
opushardware.com

